

# Kingtronics®

## DKT-DZ

### Radial, Snap-in, Screw Super Capacitor

#### FEATURES

- ◆ Radial type, Snap-in type, Screw Type terminals
- ◆ High energy and high power
- ◆ Low ESR
- ◆ Pb-free and RoHS compliant



#### APPLICATIONS

- ◆ RAM, Detonator, car recorder, smart meter, vacuum switch, digital camera, motor drive, clock circuit, UPS, toy, program-controlled switch, etc.

#### SPECIFICATIONS

Series name	DKT-DZ Series High power type	
Type name	DKT-DZ 2R7	DKT-DZ 3R0
Rated voltage $V_R$	2.7V	3.0V
Surge voltage	2.85V	3.15V
Capacity range	0.1F~3000F	1F~500F
Operating temperature range	-40~ +70°C	-40~ +65°C
Product life	Normal temperature cycle life : 25°C, 1 million cycles between $V_R$ and $1/2V_R$ , Capacity attenuation $\leq 30\%$ , ESR change $\leq 4$ times. High temperature endurance life : Maximum temperature retention $V_R$ · 1000 hours. Capacity attenuation $\leq 30\%$ , ESR change $\leq 4$ times.	

#### DIMENSIONS (mm)

0.1-120F

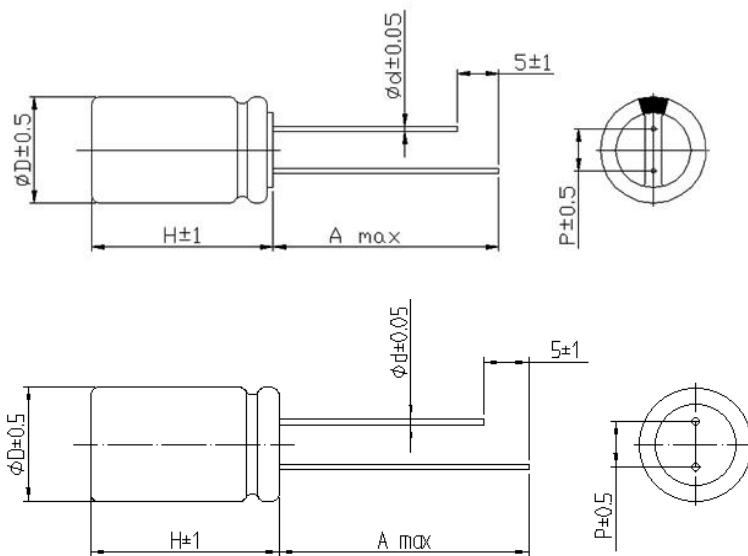

**Kingtronics® International Company**

# Kingtronics®

## DKT-DZ

### Radial, Snap-in, Screw Super Capacitor

#### DIMENSIONS (mm)

##### 90-700F

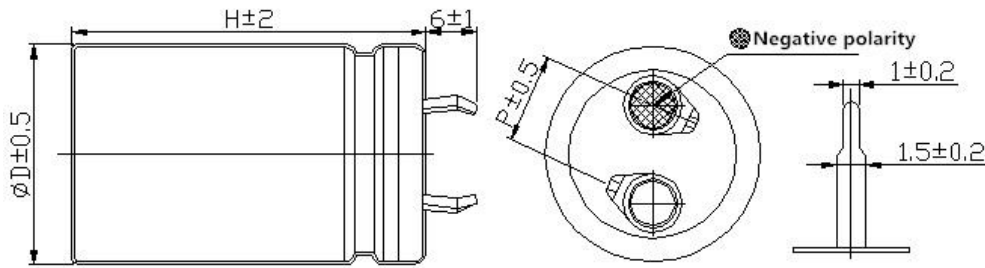

##### 350F

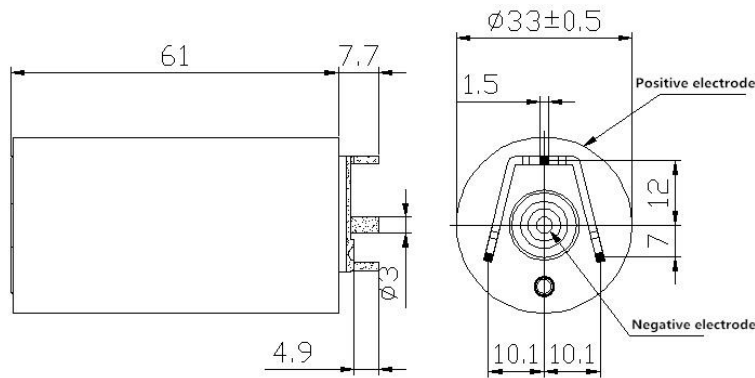

##### 3000F

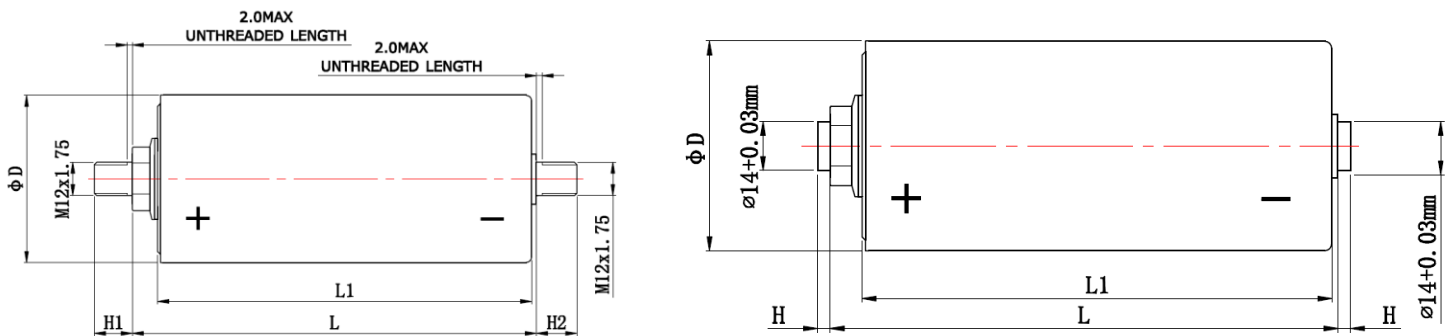

**Kingtronics® International Company**

# Kingtronics®

## DKT-DZ

Radial, Snap-in, Screw Super Capacitor

### DIMENSIONS (mm)

#### 650F~800F bolt series product size specifications

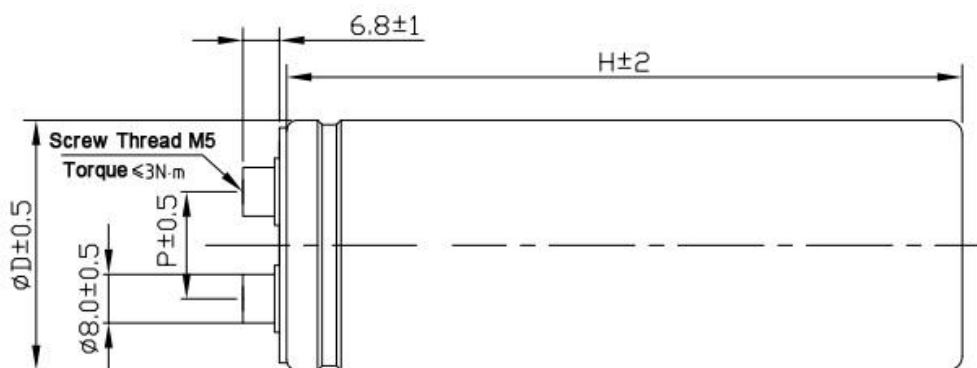

#### 1000F~2400F bolt series product size specifications

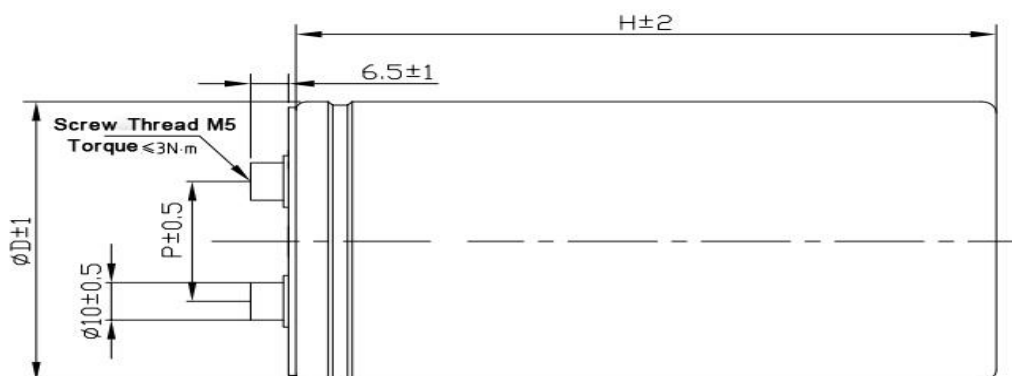

#### 3000F bolt series product size specifications

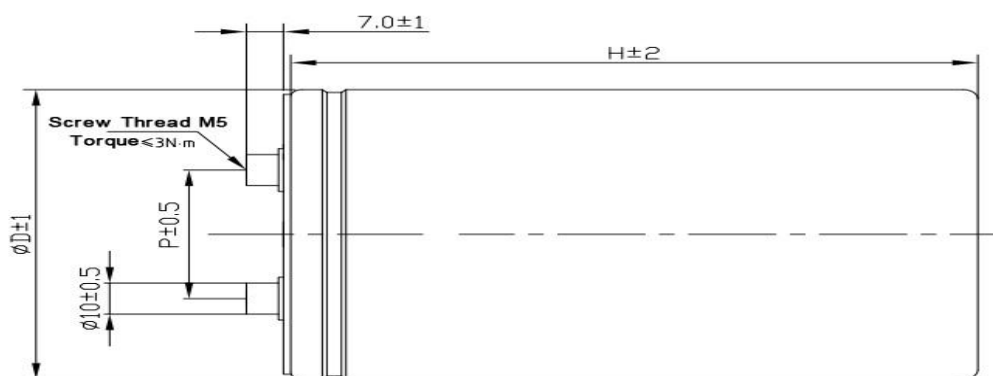

**Kingtronics® International Company**

**Kingtronics**®**DKT-DZ**

Radial, Snap-in, Screw Super Capacitor

**STANDARD RATINGS**

Capacity (F)	ESR mΩ		Product size (mm)		
	DC	AC 1kHz	Diameter	Height	Pin distance
0.1	1400	700	5	12	2
0.1	1400	700	5	10	2
0.15	500	250	5	10	2
0.2	1200	600	5	10	2
0.2	400	200	5	12	2
0.25	4000	200	5	12	2
0.35	500	250	5	12	2
0.5	700	350	6.3	10	2.5
0.5	700	350	6.3	12.5	2.5
0.7	600	300	8	13	3.5
0.7	2600	1300	4	18	1.6
1	600	300	8	13	3.5
1	1100	550	6.3	10	2.5
1	1300	650	6.3	12.5	2.5
1.5	700	350	8	13	3.5
1.5	600	300	10	13	5
1.5	700	350	6.3	14	2.5
1.5	500	250	8	16	3.5
2	480	240	6.3	22	2.5
2	500	250	6.3	17	2.5
2	400	200	8	16	3.5
2	260	130	8	20	3.5
2	240	120	10	20	5
2.2	240	120	10	20	5
3	500	250	6.3	22	2.5
3.3	500	250	6.3	22	2.5
3.3	240	120	8	20	3.5
3.3	140	70	10	20	5
4	140	70	10	20	5
4	200	100	12.5	21	5
4	200	100	8	20	3.5
4.7	120	60	12.5	21	5
5	180	90	10	20	5
5	180	90	8	24	3.5
5	180	90	8	20	3.5
6	120	60	10	25	5
6	300	150	8	24	3.5
6	150	75	10	20	5
7	160	80	10	20	5
7	160	80	8	30	3.5
8	100	50	12.5	21	5
10	80	40	12.5	25	5
10	80	40	10	34	5
10	100	50	10	25	5

**Kingtronics**® International Company

**Kingtronics**®**DKT-DZ**

Radial, Snap-in, Screw Super Capacitor

**STANDARD RATINGS**

Capacity (F)	ESR (mΩ)		Product size (mm)		
	DC	AC 1kHz	Diameter	Height	Pin distance
10	110	55	10	30	5
10	110	55	12.5	21	5
12	80	40	12.5	34	5
12	80	40	12.5	21	5
15	60	30	16	26	7.5
15	70	35	12.5	25	5
15	76	38	12.5	34	5
15	80	40	10	30	5
16	76	38	16	20	7.5
18	60	30	12.5	25	5
20	46	23	16	34	7.5
20	50	25	16	26	7.5
20	50	25	12.5	25	5
20	50	25	12.5	34	5
25	40	20	16	34	7.5
25	50	25	16	26	7.5
25	60	30	12.5	34	5
30	40	20	16	34	7.5
30	44	22	12.5	34	5
30	44	22	18	26	7.5
30	44	22	16	32	7.5
35	40	20	16	26	7.5
40	40	20	16	34	7.5
40	40	20	18	34	7.5
40	40	20	18	41	7.5
40	40	20	18	41	7.5
50	40	20	18	41	7.5
50	40	20	18	34	7.5
50	40	20	18	34	7.5
60	40	20	18	41	7.5
60	40	20	18	41	7.5
90	30	15	22	46	10
100	30	15	22	42	10
100	30	15	22	46	10
100	30	15	25.4	40	10
120	30	15	25.4	54	10
120	30	15	22	46	10
120	30	15	25.4	40	10
150	30	15	25.4	54	10
150	30	15	25.4	40	10
180	20	10	25.4	54	10
180	20	10	30	40	10
200	20	10	35	61	10
200	20	10	25.4	54	10

**Kingtronics**® International Company

**Kingtronics**®**DKT-DZ**

Radial, Snap-in, Screw Super Capacitor

**STANDARD RATINGS**

Capacity (F)	ESR (mΩ)		Product size (mm)		
	DC	AC 1kHz	Diameter	Height	Pin distance
200	20	10	30	50	10
220	20	10	30	50	10
220	20	10	35	61	10
240	20	10	30	50	10
260	20	10	30	50	10
260	20	10	35	61	10
300	20	10	35	54	10
300	20	10	35	61	10
360	7	3.5	35	61	10
400	20	10	35	61	10
470	10	5	35	61	10
500	20	10	35	61	10
550	20	10	35	70	10
600	20	10	35	70	10
650	10	5	35	96	12.7
700	10	5	35	96	12.7
800	10	5	35	96	12.7
1000	10	5	51	71	21.8
1200	6	3	51	108	21.8
1500	6	3	51	108	21.8
2000	4	2	51	133	21.8
2400	4	2	51	133	21.8
3000	4	2	64	133	28.2
350	3	1.6	35	62	/
3000	0.29	0.25	60	140	/
3000	0.29	0.25	60	140	/

**Kingtronics**® International CompanyWebsite: [www.kingtronics.com](http://www.kingtronics.com)Email: [info@kingtronics.com](mailto:info@kingtronics.com)

Tel: (852) 8106 7033

Fax: (852) 8106 7099

**Kingtronics**®**DKT-DZ**

Radial, Snap-in, Screw Super Capacitor

**HOW TO ORDER**

<b>DKT</b>	<b>DZ</b>	<b>2R7</b>	<b>104</b>	<b>M</b>	<b>00500120</b>	<b>020</b>	<b>000</b>	<b>R</b>	<b>B</b>	<b>R</b>
Series	Sub Series	Voltage	Capacity	Capacity Tolerance	Dimension	Pitch/Pins	Lead Length	Terminal Options	Packing	Pb
		1.	2.	3.	4.	5.	6.	7.	8.	9.

**NOTE:****1. Voltage**

Code	2R7	3R0
Voltage	2.7	3.0

**2. Capacity**

Code	104	105	106	107	108
Capacitance (F)	0.1	1.0	10	100	1000

**3. Capacity Tolerance**

Code	M	V	F
Tolerance	±20%	-10%~+20%	0%~+30%

**4. Dimension**

Code	00500120	00630125	01000200	01250210	01600260	05101080
Dimension (mm)	5x12	6.3x12.5	10x20	12.5x21	16x26	51x108

**5. Pitch/Pins/Screw**

Code	016	020	025	035	050	075	100	127	218	282	4PS
Pitch (mm)/ Pins	1.6	2.0	2.5	3.5	5.0	7.5	10.0	12.7	21.8	28.2	4pins
Code	000										
Pitch (mm) Screw											

**6. Lead Length**

Code	000	040	045	050
Lead Length	Standard	4.0	4.5	5.0

**7. Terminal Options**

Code	R	S	W
Terminal Options	Radial	Snap-in	Screw

**8. Packing**

Code	A	B
Packing	Ammo	Bulk

**9. Pb**

Code	L	R
Pb	Leaded	RoHS

Note: Specifications are subject to change without notice.

**Kingtronics**® International Company