

Kingtronics®**BAT54S**
SCHOTTKY
BARRIER DIODE**FEATURES**

Low Forward Voltage
Fast Switching
Surface Mount device
For General Purpose Switching Applications

MECHANICAL DATA

Case: SOT-23
Case Material: Molded Plastic. UL flammability
Classification Rating: 94V-0
Moisture Sensitivity: Level 1 per J-STD-020
Weight: 0.013 grams (approximate)

MAXIMUM RATINGS ($T_A = 25^\circ\text{C}$ unless otherwise noted)

PARAMETER	SYMBOL	VALUE	UNIT
Reverse Voltage	V_R		
Peak Repetitive Peak Reverse Voltage	V_{RRM}	30	V
Working Peak Reverse Voltage	V_{RWM}		
Forward Continuous Current	I_F	200	mA
Non-repetitive Peak Forward Surge Current @ $t=8.3\text{ms}$	I_{FSM}	600	mA
Repetitive Peak Forward Current @ $t \leq 1\text{s}, \delta \leq 0.5$	I_{FRM}	300	mA
Power Dissipation	P_D	200	mW
Thermal Resistance From Junction To Ambient	$R_{\theta JA}$	500	$^\circ\text{C}/\text{W}$
Junction Temperature	T_J	125	$^\circ\text{C}$
Storage Temperature	T_{stg}	-55~+150	$^\circ\text{C}$

ELECTRICAL CHARACTERISTICS ($T_A = 25^\circ\text{C}$ unless otherwise specified)

PARAMETER	SYMBOL	MIN.	MAX.	UNIT	CONDITION
Reverse breakdown voltage	$V_{(BR)}$	30		V	$I_R=100\mu\text{A}$
Reverse voltage leakage current	I_R		2	μA	$V_R=25\text{V}$
Forward voltage	V_{F1}		0.24	V	$I_{F1}=0.1\text{mA}$
Forward voltage	V_{F2}		0.32	V	$I_{F2}=1\text{mA}$
Forward voltage	V_{F3}		0.40	V	$I_{F3}=10\text{mA}$
Forward voltage	V_{F4}		0.50	V	$I_{F4}=30\text{mA}$
Forward voltage	V_{F5}		1	V	$I_{F5}=100\text{mA}$
Diode capacitance	C_D		10	pF	$V_R=1\text{V}, f=1\text{MHz}$
Reverse recovery time	T_{rr}		5	nS	$I_F=I_R=10\text{mA}$ $I_{rr}=0.1 \times I_R$ $R_L=100\Omega$

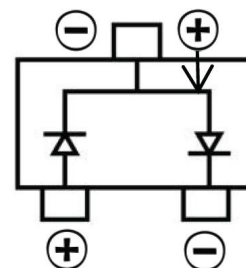
SOT-23

BAT54S:KL4

Kingtronics® International Company

Website: www.kingtronics.com Email: info@kingtronics.com Tel: (852) 8106 7033 Fax: (852) 8106 7099

Kingtronics®

BAT54S SCHOTTKY BARRIER DIODE

Typical Characteristics

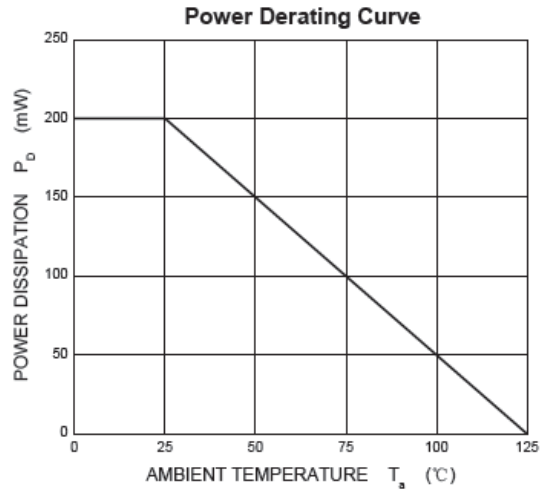
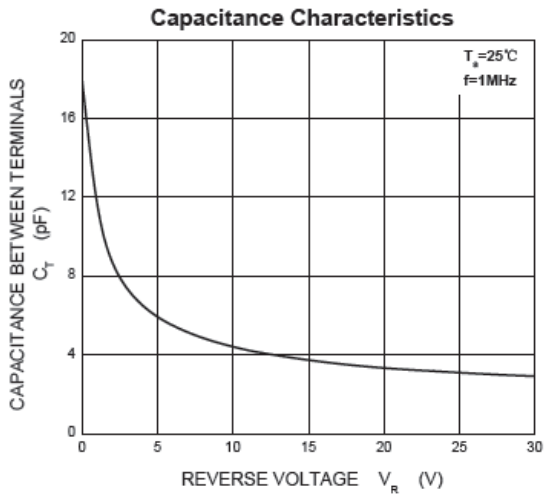
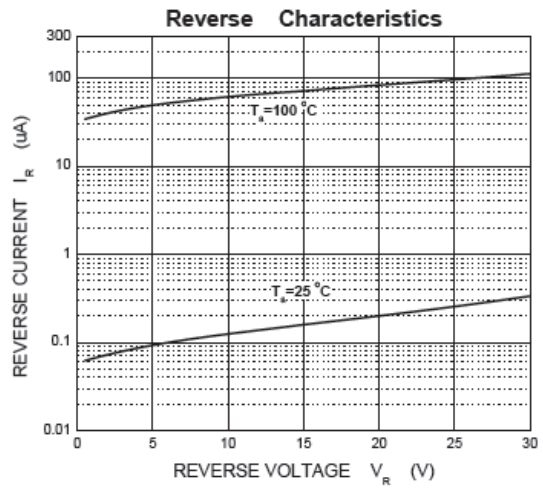
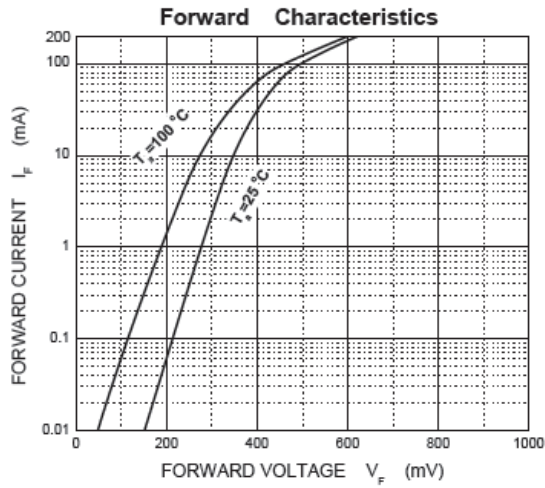

Kingtronics® International Company

Kingtronics®

BAT54S SCHOTTKY BARRIER DIODE

SOT-23 Package Outline Dimensions

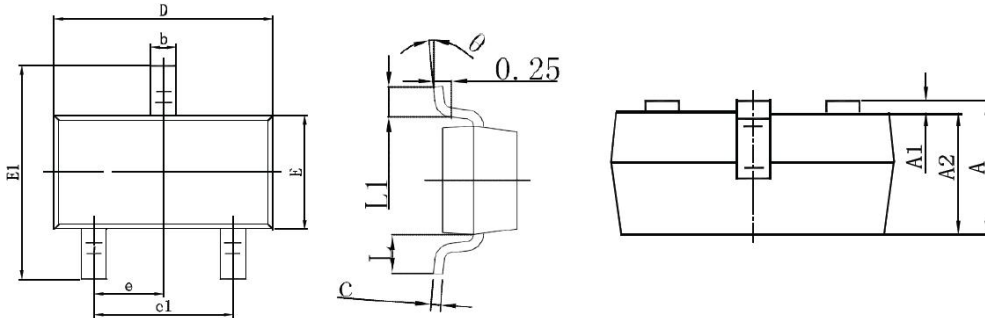

Symbol	Dimensions In Millimeters		Dimensions In Inches	
	Min.	Max.	Min.	Max.
A	0.900	1.150	0.035	0.045
A1	0.000	0.100	0.000	0.004
A2	0.900	1.050	0.035	0.041
b	0.300	0.500	0.012	0.020
c	0.080	0.150	0.003	0.006
D	2.800	3.000	0.110	0.118
E	1.200	1.400	0.047	0.055
E1	2.250	2.550	0.089	0.100
e	0.950 TYP		0.037 TYP	
e1	1.800	2.000	0.071	0.079
L	0.550 REF		0.022 REF	
L1	0.300	0.500	0.012	0.020
θ	0°	8°	0°	8°

SOT-23 Suggested Pad Layout

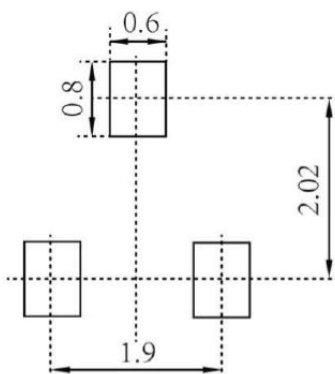

Note:

1. Controlling dimension: in millimeters
2. General tolerance: $\pm 0.05\text{mm}$
3. The pad layout is for reference purposes only

Note: Specifications are subject to change without notice.

Kingtronics® International Company

Website: www.kingtronics.com Email: info@kingtronics.com Tel: (852) 8106 7033 Fax: (852) 8106 7099